

# Installation

Wiring diagram

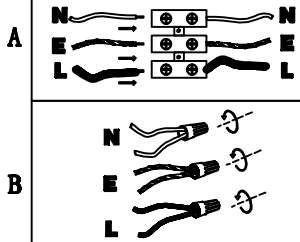

Ceiling installation diagram

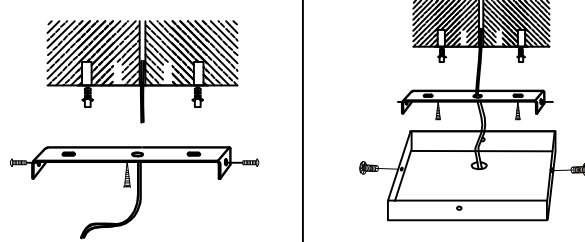

Ceiling base size: 200\*200\*40MM

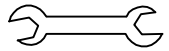
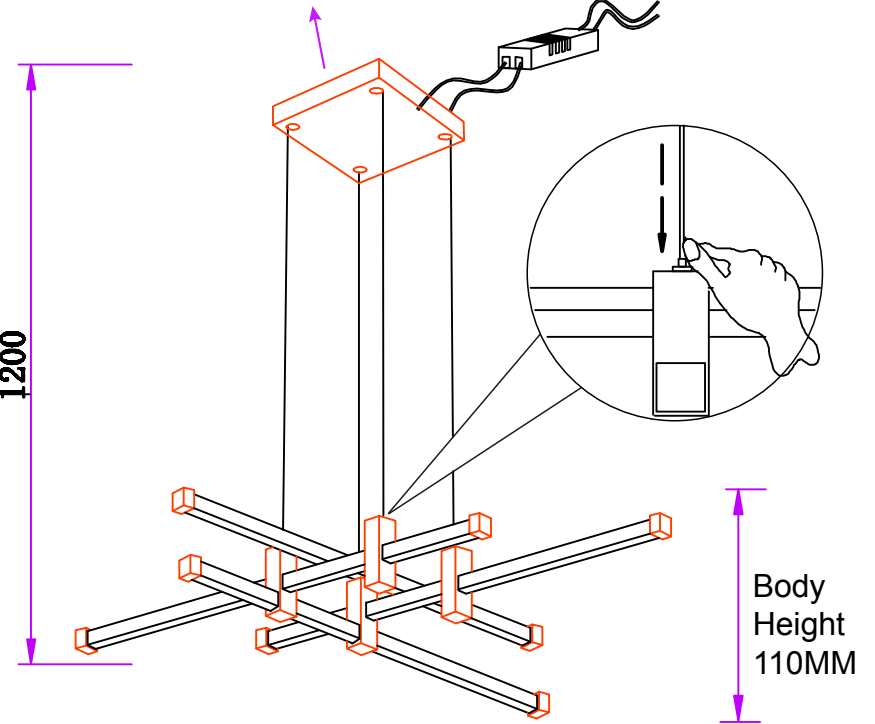

Wrench

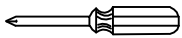

Bolt driver

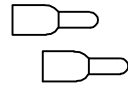

Terminal

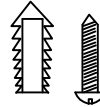

Screw



## Matters needing attention

- 1 Rated power:220-240V, 50Hz, bulb power≤40W.
- 2 Do not scratch the lamp surface and wire during installation, and wear gloves during installation.
- 3 The red wire of each luminaire shall connect phase line, assorted color line to zero line, ground line at ground mark.
- 4 Do not install in the ceiling that did not dry fully, the environment should be ventilated, dry.
- 5 The lamps and lanterns should not be close to acid or corrosive chemical objects or gases. They should not be cleaned with water and only be wiped with a clean soft cloth.

