

2116/09/06P

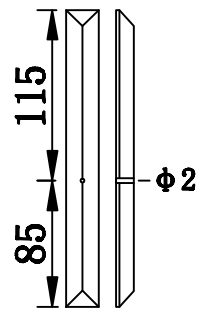
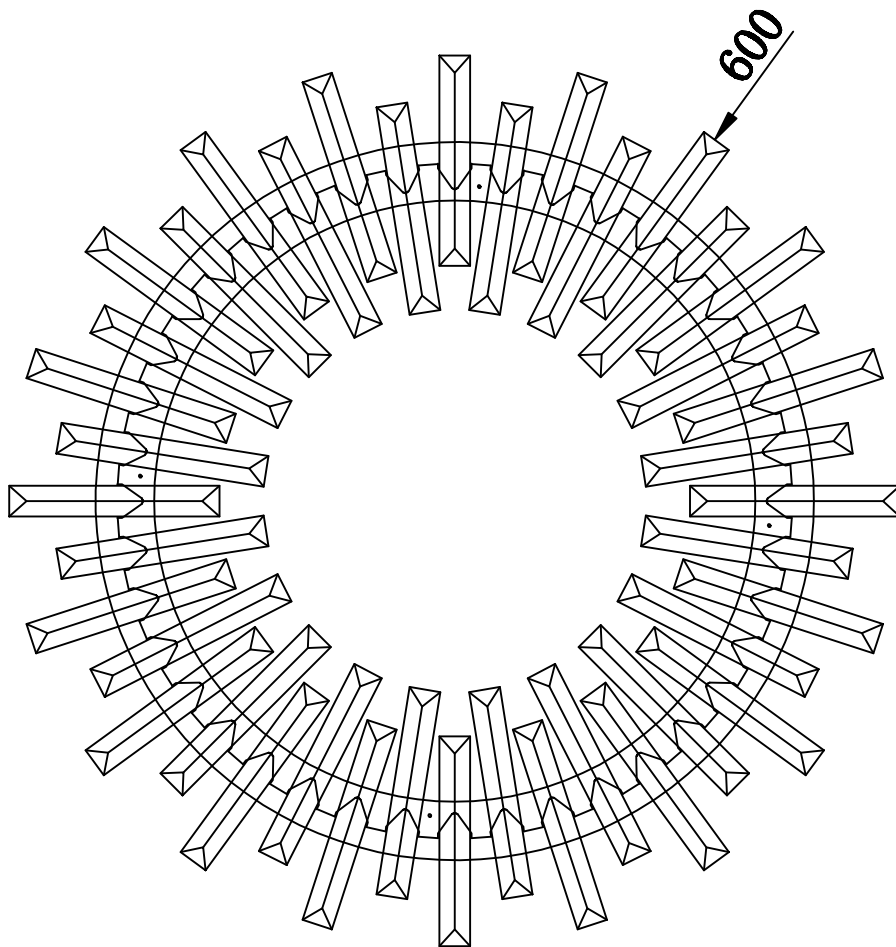
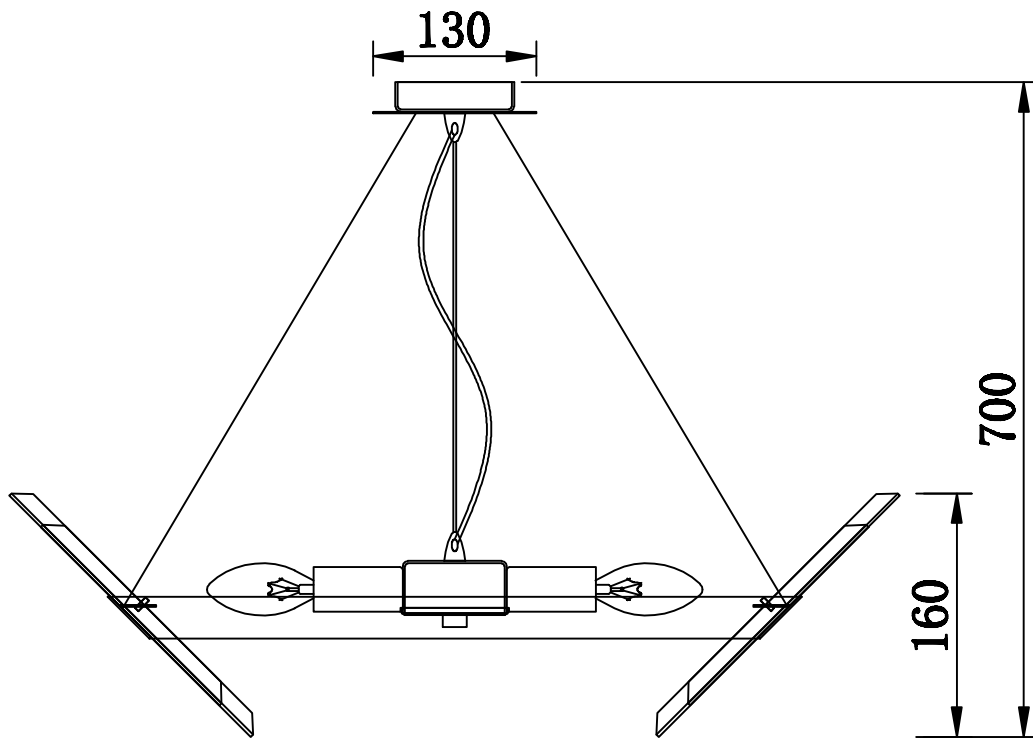

200*22mm长条 中孔